



English



[profurl.com](http://profurl.com)



Roland Jourdain - We Explore - 2022 Route du Rhum

# FURLING SYSTEMS





# SPINEX

TOP DOWN  
SPINNAKER FURLER  
WITH RATCHET

# Top down spinnaker furler

## SPINEX

First launched a decade ago, the next generation of SPINEX includes new innovations to provide even greater user comfort and enhanced furling performance.

SPINEX in short:

- > 6 models available: SPINEX 0.9, SPINEX 1.5, SPINEX 2.5, SPINEX 4.0, SPINEX 6.5 and SPINEX 8.0
- > For boats from 5 to 18m long, and asymmetrical spinnakers up to 400 m<sup>2</sup>
- > All-in-one system: mechanisms, anti-torque cable, fittings, flexible PVC sleeves, 2-in-1 thimbles, and a swivel tack point
- > The SPIN KIT is available separately for use on NEX reefing systems and other brands on the market (Facnor, etc.)
- > Integrated Profurl technology
- > International 3-year guarantee

## Why choose Spinex

### Easy to use, safe, efficient, adaptable

Using asymmetric spinnakers in some conditions can be dangerous. With the Spinex, you're going to rediscover the joys of this type of sailing because it allows you to:

- > Easily handle this type of sail (even short-handed)
- > Remain in the safety of the cockpit
- > Improve the performance of your sailing-boat by using downwind sails

### Adaptable: One system for many uses

The Spinex can easily be converted into a NEX by removing the swivel tack from the drum and the end fittings, and then it can be used for sails like a gennaker or a code zero.



## Innovations in the next generation of SPINEX solutions

### Greater furling comfort and performance

#### Easy to use, offering improved performance for your sailing boat:

- Replacement of the traditional balls with a flexible PVC sheath, offering full UV and twist resistance
- Up to 50% reduced weight
- Easy to store once the sail is furled

#### Improved furling performance:

- One specific anti-torque cable diameter per model
- Improved furling, adapted to the size of the sails

#### Easy to install

- A new, innovative 2-in-1 thimble: thimble + clamp for faster installation



## Top down furling

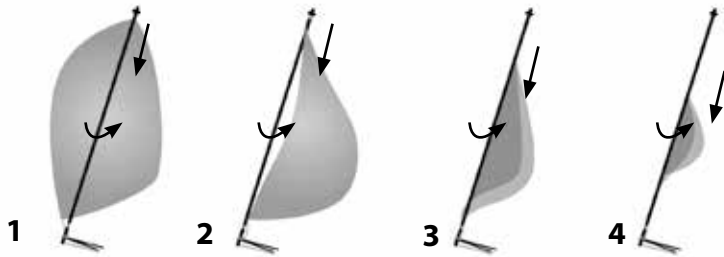

> When it comes to asymmetric spinnakers, top down furling is the best solution for bringing in your sail. The concept first appeared on maxi yachts before filtering down to more modestly-sized sailing-boats.

> Thanks to its swivel tack, the sail can be furled from the top downward to progressively stifle the sail without creating a jam.

## Which sails ?

> The Spinex is designed to furl flying sails with a loose luff, such as asymmetrical spinnakers.

> Gennakers, code zeros, staysails and so on can be furled using a NEX furler (see page 24 of this catalogue).

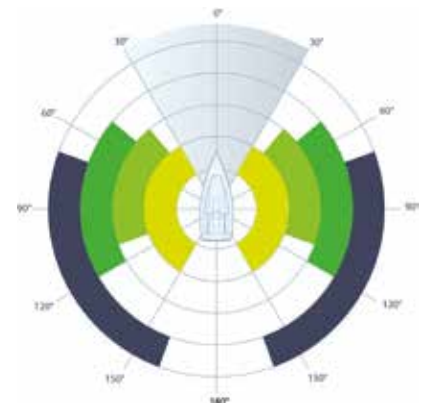

**SPINEX** Asymmetric spinnaker

**NEX** {  
 Genoa / staysail  
 Code 0  
 Gennaker

# Top down spinnaker furler

## SPINEX

### SPINEX components

- 1 Innovative ratchet feature : Furlassist
- 2 Large spool diameter
- 3 Innovative thimble: 2 in 1
- 4 Swivel tack point with Dyneema® loop
- 5 PVC sleeves to protect the sail
- 6 Anti-torque cable
- 7 Spool & swivel



### FURL ASSIST RATCHET: A MAJOR INNOVATION

#### A REAL PLUS FOR FURLING OPERATIONS

- Better control of furling
- Avoids accidental unfurling of the sail
- Permanent engagement of the pawl
- Safety: unlocks when hauling in the line fast
- Operates in both directions
- No additional line
- Easy installation and removal (2 screws)

## CHOOSE THE RIGHT SPINEX FOR YOU (5–18 M BOATS):

	SPINEX 0.9	SPINEX 1.5	SPINEX 2.5	SPINEX 4.0	SPINEX 6.5	SPINEX 8.0
<b>Boat length (not contractual)</b>	up to 8 m	up to 10 m	up to 12 m	up to 15 m	up to 18 m	+ 20 m
<b>Sail area recommended</b>	up to 60 m <sup>2</sup>	up to 100 m <sup>2</sup>	up to 150 m <sup>2</sup>	up to 230 m <sup>2</sup>	up to 300 m <sup>2</sup>	up to 400 m <sup>2</sup>
<b>Maximum working load</b>	900 Kg	1500 Kg	2500 Kg	5000 Kg	6500 Kg	8000 Kg
<b>Spool diameter</b>	120 mm	150 mm	180 mm	220 mm	220 mm	250 mm
<b>Lower end fitting</b>	Clevis pin snap shackle				Trigger snap shackle	-
<b>Upper end fitting</b>	D shackle					-
<b>Anti-twist cable Ø</b>	9 mm	11 mm	13 mm	15 mm	17 mm	19 mm
<b>Cable length delivered as standard</b>	14 m	17 m	20 m	25 m	30 m	35 m

\*: The working loads shown are the maximum working loads of the mechanisms (spool and swivel) only and are not the loads of the complete system when terminals are included. The product should not be used above these working loads in any circumstances.

### SPINEX: content



### Are you already using a Profurl NEX furler and want to furl your asymmetric spinnaker? Get the SPIN KIT!

Use Profurl's SPIN KIT to turn NEX furlers into asymmetric spinnaker furlers. SPIN KIT includes anti-twist cable, soft sleeves, and upper and lower end fittings.

	SPIN 0.9	SPIN 1.5	SPIN 2.5	SPIN 4.0	SPIN 6.5	SPIN 8.0
<b>Boat length (not contractual)</b>	up to 8 m	up to 10 m	up to 12 m	up to 15 m	up to 18 m	+ 20 m
<b>Part #NEX</b>	NEX 0.9	NEX 1.5	NEX 2.5	NEX 4.0	NEX 6.5	NEX 8.0
<b>Cable length delivered as standard</b>	14 m	17 m	20 m	25 m	30 m	35 m

# Top down spinnaker furler

## SPINEX

### ADVICES FOR USING THE SPINEX

#### 1st time:

> When setting for the first time, we recommend you do this in light winds. Check all halyard and sheet leads.

#### Furling:

> Tension must be applied to anti-twist cable by hauling on the halyard. It should be taut and stable. Be careful not to apply excessive tension, especially when you use an electric winch.

#### Direction of furling:

> As the anti-twist cable is a shape-memory component, we recommend you always furl your sail in the same direction to facilitate handling.

#### Wind angles:

> When unfurling the sail, stay within an apparent angle of between 90 and 120 degrees to help setting.

When furling, the apparent angle must be within 130 and 150 degrees (with the mainsail set to the head of the mast).



### INSTALLATION ADVICES

Fig 1.1

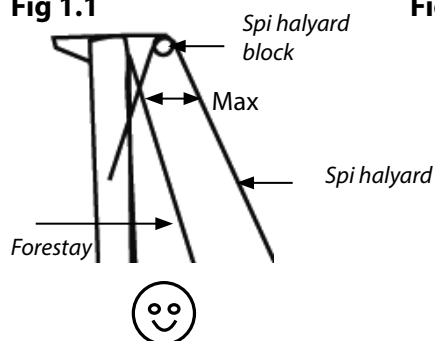

Fig 1.2.



Fig 2.1.

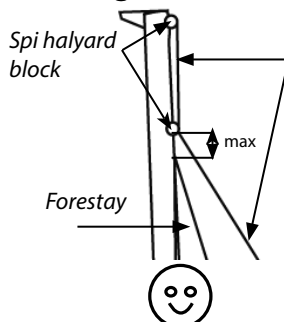

Fig 2.2

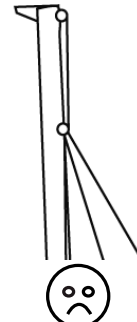

Fig 3.1



Fig 3.2.



Fig 4.1

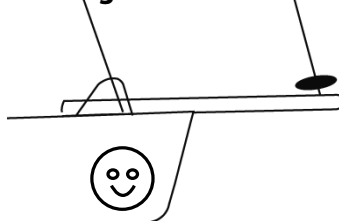
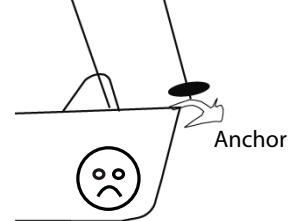

Fig 4.2.



## Technical data: SPINEX

	SPINEX 0.9	SPINEX 1.5	SPINEX 2.5	SPINEX 4.0	SPINEX 6.5	SPINEX 8.0
<b>A mm</b>	113.80	120.70	154	180.70	225.40	-
<b>B mm</b>	63.30	80.20	100.30	122.70	146.10	160
<b>C mm</b>	80	87	93	103	126	126
<b>D mm</b>	31.50	35	40	47.10	55.40	56.40
<b>E mm</b>	127.50	139.50	151.50	163	209	216
<b>F mm</b>	34	37	42	47	53	60
<b>G mm</b>	19	21	25.50	28.50	33	33
<b>H mm</b>	8.30	8.30	10.30	12.30	14.30	14.30
<b>I mm</b>	10	10	12	14	17	18
<b>∅ spool: mm</b>	120	150	180	220	220	250
<b>∅ furling line: mm</b>	8	8	8 - 10	8 - 10	10	10
<b>∅ anti-torque cable mm</b>	9	11	13	15	17	19
<b>Weight: swivel tack point, lower thimble Kg</b>	0.490	0.620	0.830	1.060	1.870	1.880
<b>Weight: upper thimble Kg</b>	0.120	0.170	0.245	0.310	0.580	0.590
<b>Weight: cable &amp; sleeve per meter (Kg / m)</b>	0.160	0.210	0.275	0.345	0.420	0.500

Technical data for mechanism

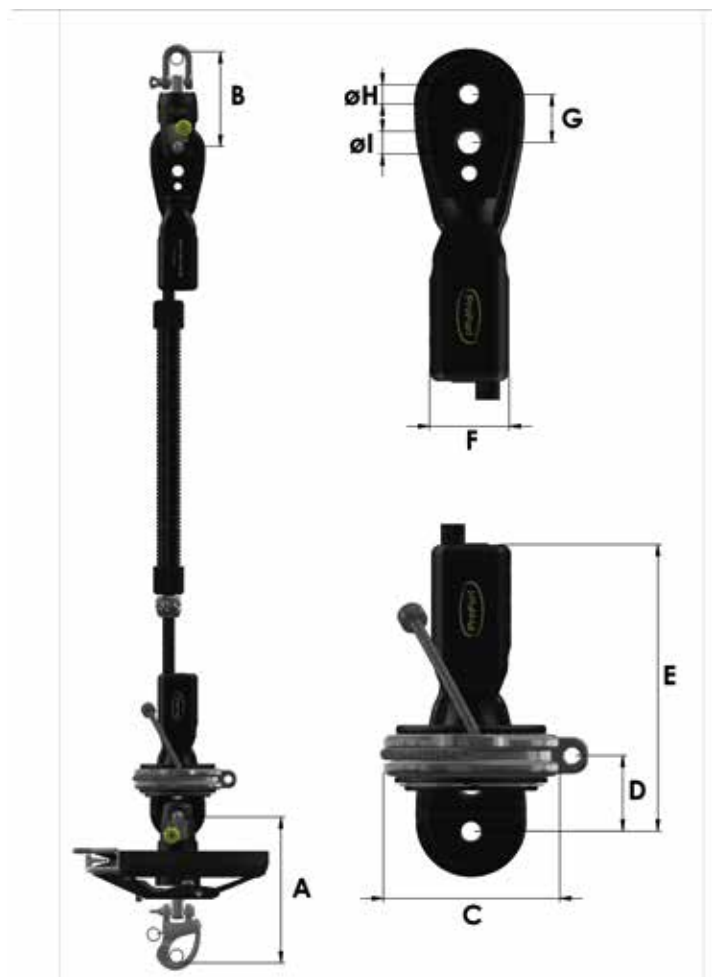



# Accessories

## for furlers and flying sail furlers



20120



21020

Part #	Description	Applications
20120	Stainless steel single fairlead For 25mm stanchion Maximum line diameter : 20mm	For manual headsail, flying sail and stayfurlers with drum
21020	Deck fairlead – M10 screw	For manual headsail, flying sail and stayfurlers with drum
20220	Stainless steel double fairlead with Velcro stripe for continuous line. For 25mm stanchion maximum Maximum line diameter : 20mm -	For flying sail and stayfurlers with spool
21220	Stainless steel double fairlead with Velcro stripe for continuous line. For 28mm stanchion maximum Maximum line diameter : 20mm	For flying sail and stayfurlers with spool
21120	Stainless steel articulated fairlead - For 25 & 28mm stanchion maximum Maximum line diameter : 20mm	For manual headsail, flying sail and stayfurlers with drum
20320	Deck fairlead - max rope size: 18 mm Fitting with 2 M5 screws	For manual headsail, flying sail and stayfurlers with drum

20220 /  
21220



21120



20320

### NEX AND SPINEX FLYING SAIL FURLERS: SPliced FURLING LINES – STANDARD LENGTH POLYESTER BRAID / BEIGE

For models	Line Part #	Description
NEX 0.9, SPINEX 0.9	54122	Dia 8 mm - standard length L: 12 m
	54123	Dia 8 mm - standard length L: 14 m
	54124	Dia 8 mm - standard length L: 16 m
NEX1.5, NEX 2.5, NEX 4.0, NEX6.5 - SPINEX 1.5, SPINEX 2.5, SPINEX 4.0	54129	Dia 10 mm - standard length L: 14 m
	54125	Dia 10 mm - standard length L: 16 m
	54126	Dia 10 mm - standard length L: 18 m
	54127	Dia 10 mm - standard length L: 20 m
	54128	Dia 10 mm - standard length L: 22 m
	54131	Dia 10 mm - standard length L: 24 m
54174	Dia 10 mm - standard length L: 26 m	

### MANUAL HEADSAIL FURLERS: SPliced FURLING LINES – STANDARD LENGTH

For models	Line Part #	Description
C260, C320, R250, R350	P250901	20 m reefing line ø. 6 + 1 articulated fairlead# Wichard 21120 + 3 single fairleads # Wichard 20120
C290, C350, C420, C430, R350, R420, R430	P250902	25 m reefing line ø. 8 + 1 articulated fairlead# Wichard 21120 + 4 single fairleads # Wichard 20120
C350, C420, C430, C480, R350, R420, R430, R480	P250903	25 m reefing line ø. 10 + 1 articulated fairlead# Wichard 21120 + 4 single fairleads # Wichard 20120
C430, C480, C520, C530, R420, R430	P250904	30 m reefing line ø. 10 + 1 articulated fairlead# Wichard 21120 + 5 single fairleads # Wichard 20120



# PROFURL DISTRIBUTORS PER COUNTRY

Country	Name	Zip code	Town	Area code	Phone	E-mail
Australia	Wichard Pacific Pty Ltd	NSW 2044	St Peters	61	295 160 677	info@wichard.com.au
Azores	Boat & Sailservice	9500-771	Sao Miguel	351	963925707	boatsailservice@gmx.net
Azores	Mid Atlantic Yacht Services	9900-114	Horta	351	292 391 616	mays@mail.telepac.pt
Belgium	Elvstrom Sails Benelux	2000	Antwerpen	32	0 495707870	info@elvstromsails.be
Belgium	Plaisance Diffusion	1030	Bruxelles	32	0 2 216 79 34	info@plaisance.be
Belgium	Technique Voile	4432	Alleur	32	0 42 63 4041	info@technique-voile.be
Belgium	West Diep Yachting Center	8620	Nieuwpoort	32	0 58 23 40 61	info@westdiep.com
Belgium	Wittevrongel Sails BV	8370	Blankenberge	32	04 96 28 45 75	ian@wittevrongel.be
Belgium	Wittevrongel Rigging	8370	Blankenberge	32	04 96 28 45 76	steve@wittevrongel.be
Brazil	Rio Sail Tech	22290-240	Rio de Janeiro	55	254 202 33	contato@riosailtech.com.br
Canada	WPG Canada	JOB 3G0	Stoke (Québec)	1	819 878 30 18	info@wichard.ca
Canary islands	Nordest	38370	La Matanza Tenerife	34	922 577 322	nordest@nordest-canarias.com
Chile	Oceanic Chile		Santiago	562	244 20 20	contacto@oceanic.cl
China	Sunrise Marineware Ltd		Shenzhen	86	755 866 50 101	sales@sunrisemw.com
Croatia	Aspar Rigging	51211	Matulji	385	51 343 230	aspar-rigging@ri.t-com.hr
Croatia	Ramina Pomorstvo	21000	Split	385	2139 82 33	office@raminapomorstvo.hr
Denmark	PS Rigging	6200	Aabenraa	45	31 69 31 39	info@ps-rigging.com
Dutch Caribbean	Budget Marine St Martin		Philipsburg	1	5 995 443 134	stmaarten@budgetmarine.com
Dutch Caribbean	FKG Marine St Martin		Philipsburg	599	544 47 33	info@fkgmarine.com
Finland	Oy Maritim AB	210	Helsinki	358	10 27 40 320	maritim@maritim.fi
France	Wichard S.A.S	63300	Thiers	33	(0)4 73 51 65 00	marine@wichard.com
French Polynesia	Tahiti Sport / Nauti Sport	98713	Papeete	689	50 59 59	tahiti.sport@tahiti-sport.pf
Germany	Pfeiffer Marine Gmbh	78345	Moss am Bondesee	49	07732 9950 32	info@pfeiffer-marine.de
Greece	Nautilus	17455	Alimos / Athens	30	210 98 54 238	info@nautilus.gr
Greece	A.Andreou & Co	Tk 18346	Athens	30	210 48 28 452	info@aandreou.gr
Greece	Waypoint	31100	Lefkas	30	26450 21461	info@waypointsails.com
Grenada	Turbulence Ltd Grenada		Prickly bay	473	439 44 95	info@turbulenceld.com
Guadeloupe	Caraibe Greement Guadeloupe	97110	Pointe À Pitre	590	90 82 01	carabegreement@hotmail.com
Hong Kong	Storm Force Marine Ltd		Wanchai	852	28 660 114	sales@stormforcemarine.com
Hungaria	Fuke Yachts (Hullam 04)	8220	Balatonalmadi	36	884 328 97	info@fukeyacht.hu
Ireland	Masts & Rigging Ireland Ltd	A92 TP49	Duleek	353	41 988 0389	info@riggers.ie
Israel	Atlantis Marine	63453 25	Tel Aviv	972	(03) 522 7978	atlantis@inter.net.il
Italy	C-Marine S.r.l	19030	Bocca Di Magra - Sp	39	0187 67 08 28	info@cmarine.it
Japan	Cosmos Marine Ltd	556-0023	Osaka	81	665 672 397	cosmarin@pure.ne.jp
Japan	Marine Services Kojima	236-0003	Kanagawa	81	457 903 581	toiawase@mskojima.co.jp
Malta	Gauci Borda	GZR03	Gzira	356	2131 3758/3748	info@gauciborda.com
Martinique	Caraibe Marine	97290	Le Marin	596	74 80 33	cgmar@wanadoo.fr
Netherlands	Masterspars	1693 BN	Wervershoof	31	(0)610627948	sales@masterspars.com
New Caledonia	Marine Corail	98800	Nouméa	687	27 58 48	info@marine-corail.nc
New Caledonia	Pacific Accastillage	98845	Nouméa	687	78 78 46	pacificaccastillage@gmail.com
New Zealand	Kiwi Yachting	90114	Auckland	64	9 36 00 30 0	sales@kiwiyachting.co.nz
Norway	Southern Cross Spars AS	1363	Høvik	47	(0)95977482	info@southerncross.no
Poland	Majer Na Fali	01-971	Varsovie	48	533 655 095	office@majernafali.pl
Portugal	Lisnautica Lda	1300-340	Lisbon	351	21 36 39 084	lisnautica@gmail.com
Portugal	Just Boats Lda	8100-263	Loule	351	281 971 179	info@just-boats.net
Portugal	Blaus 3 Sailing Services	8100-068	Boliquime	351	916 267 103	info@blaus.pt
Réunion Island	La voilerie du port	97420	Le Port	33	(0)6 92 21 76 69	voilerieduport@hotmail.com
Russia	Fordewind-Regatta	197110	Saint Petersburg	7	8 123 201 853	info@fordewind.spb.ru
Saint Martin	Yacht Rigging St Martin	97150	Saint Martin	590	29 52 52	mustyachtrigging@domaccess.com
Singapore	Intermarine Supply	639078	Jurong	65	686 33 966	ropes@intermarine.com.sg
Slovenia	Skipper Portoroz	6320	Portoroz	386	5 67 770 11	skipper@siol.net
South Africa	Sparcraft Masts	7435	Cape Town	27	(0)21 555 3340	info@sparcraftmasts.co.za
Spain	YangBela Technic Sail S.L.	20280	Hondarribia	34	9 436 44 459	edouardo@yangbela.com
Sweden	Liros Skandinavia AB	42750	Bilidal	46	3191 52 00	info@lirosropes.se
Switzerland	Megroz Voiles	1070	Puidoux	41	21 946 49 49	pm@fragniere-megroz.ch
Switzerland	MW Matelotage	1252	Meinier	41	79 203 41 11	denis.menetrey@mwmatelotage.ch
Taiwan	Storm Force Marine Ltd		Wanchai	852	28 660 114	sales@stormforcemarine.com
Thailand	Storm Force Marine Ltd		Wanchai	852	28 660 114	sales@stormforcemarine.com
Trinidad and Tobago	Budget Marine Trinidad Ltd		Chaguaramas	1	868-634-2006	trinidad@budgetmarine.com
Turkey	Prima Deniz	34728	Istanbul	90	216352240	kayayelken@superonline.com
United Kingdom	Proboat Ltd	CMO 8TE	Burnham-On-Crouch	44	1 621 78 54 55	sales@proboat.co.uk
Uruguay	Kraen Sa	70.000	Colonia	598	52-23814	kraen@adinet.com.uy
USA	Wichard, Inc.	NC 28206	Charlotte	1	4 016 835 055	usales@wichard.com

# They sail with Profurl !



Pogo 44



Outremer 5.X  
We Explore - Roland Jourdain



Victoire Martinet  
Mini 6.50



Bureau Vallée 3 - L Burton  
Imoca 60

**WICHARD S.A.S**  
1, ZI de Felet - CS 50085  
63307 Thiers Cedex  
France  
Tel +33 (0)4 73 51 65 00  
E-mail : marine@wichard.com

**Hotline / Technical Support /  
After sales service**  
Z.A Pornichet Atlantique  
16 av du Gulf Stream  
44380 Pornichet - France  
Tel +33 (0)2 51 76 00 35  
E-mail : hotline@wichard.com

**WICHARD, Inc.**  
**North America**  
3901 Pine Grove Circle  
Charlotte, NC 28206  
Tel: +1 (401) 683-5055  
Fax: +1 (802) 655-4689  
E-mail: usasales@wichard.com

**WICHARD Pacific Pty Ltd**  
PO Box 104 St Peters  
NSW 2044  
Australia  
Phone: +61 2 9516 0677  
Fax: +61 2 9516 0688  
E-mail: info@wichard.com.au